

Assembly Drawing (Type: W110)

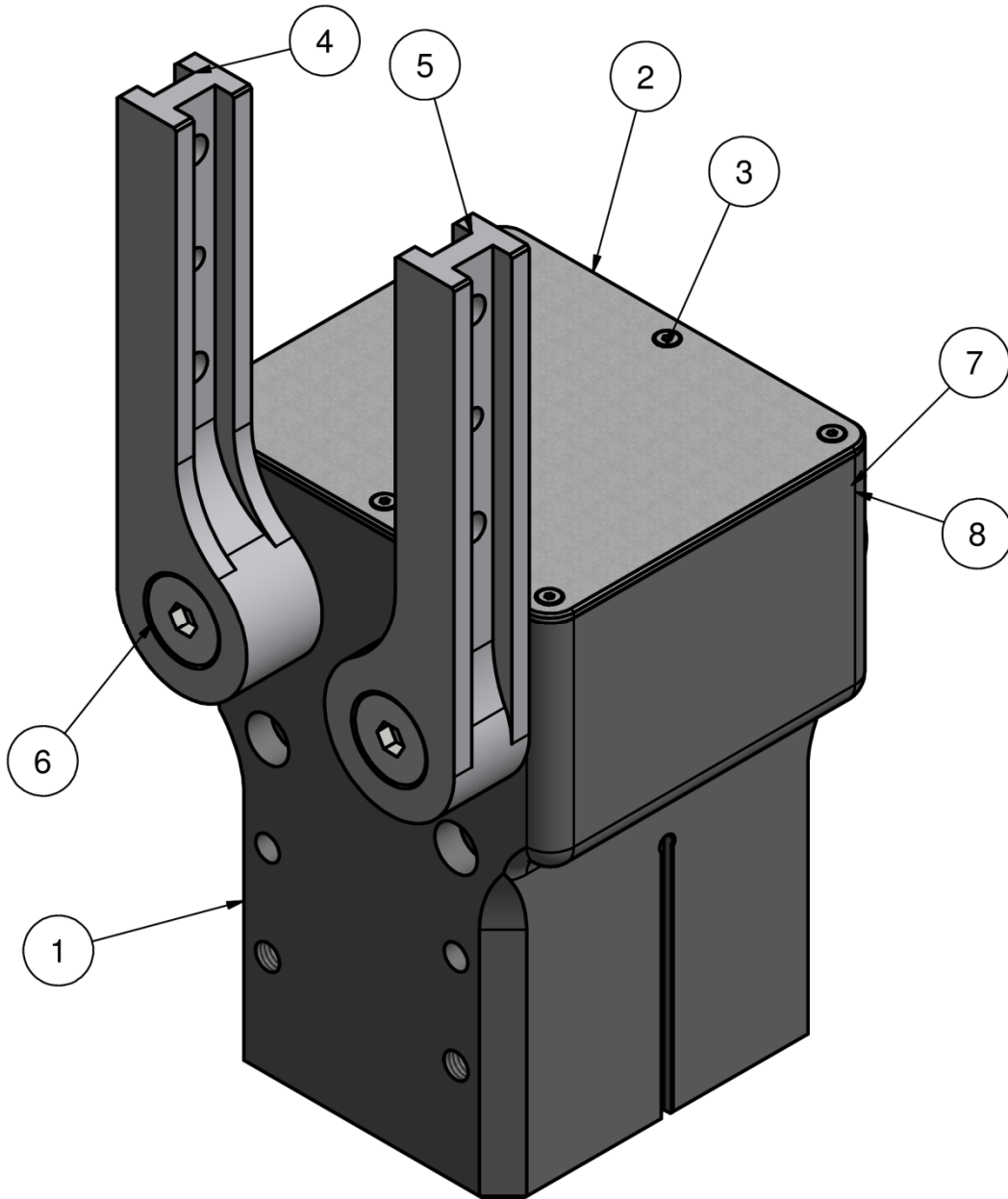

Address:

GMG – Gesellschaft fuer modulare
Greifersysteme mbH
Coesterweg 45c • 59494 Soest
Germany

Phone:

+49 (0)2921 - 4062

Fax:

+49 (0)2921 - 4042

E-mail:

info@gmg-system.com

Homepage:

<http://www.gmg-system.com>

Spare Part List for Gripper **W110**

Gear Unit

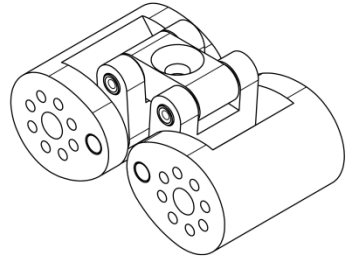
Pos.	Article	Quantity	Order Number: 1201-WG10-GE10
	Gear Unit	1	

Piston Unit

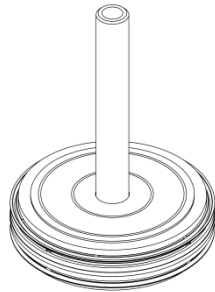
Pos.	Article	Quantity	Order Number: 1202-WG10-KE10
	Piston Unit	1	

Finger Right (single)

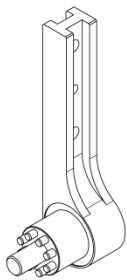
Pos.	Article	Quantity	Order Number: 1203-WG010-FR10
5	Finger Right	1	
6	Fixing Screw	1	
	Pin	8	

Address:

GMG – Gesellschaft fuer modulare Greifersysteme mbH
 Coesterweg 45c • 59494 Soest
 Germany

Phone:

+49 (0)2921 - 4062

Fax:

+49 (0)2921 - 4042

E-mail:

info@gmg-system.com

Homepage:

http://www.gmg-system.com

Spare Part List for Gripper **W110**

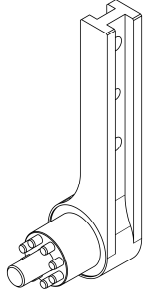
Finger Left (single)			
<i>Pos.</i>	<i>Article</i>	<i>Quantity</i>	Order Number: 1203-WG10-FL10
4	Finger Left	1	
6	Fixing Screw	1	
	Pin	8	

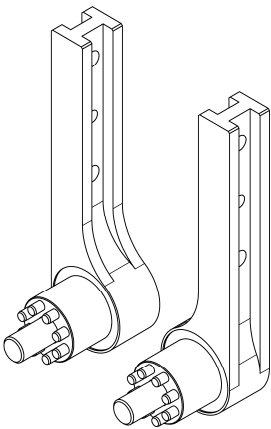
Finger Pair			
<i>Pos.</i>	<i>Article</i>	<i>Quantity</i>	Order Number: 1203-WG10-FP10
4	Finger Left	1	
5	Finger Right	1	
6	Fixing Screw	2	
	Pin	16	

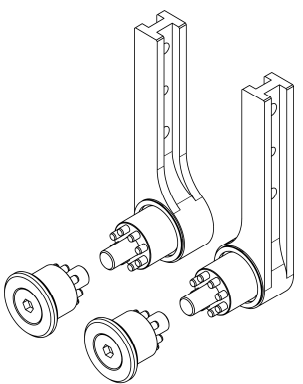
Finger Set			
<i>Pos.</i>	<i>Article</i>	<i>Quantity</i>	Order Number: 1203-WG10-FS10
7	Counter Bearing	2	
4	Finger Left	1	
5	Finger Right	1	
6	Fixing Screw	4	
	Pin	32	
	Finger Seal	4	

Address:

GMG – Gesellschaft fuer modulare Greifersysteme mbH
Coesterweg 45c • 59494 Soest
Germany

Phone:

+49 (0)2921 - 4062

Fax:

+49 (0)2921 - 4042

E-mail:

info@gmg-system.com

Homepage:

http://www.gmg-system.com

Spare Part List for Gripper **W110**

Seal Kit (small)

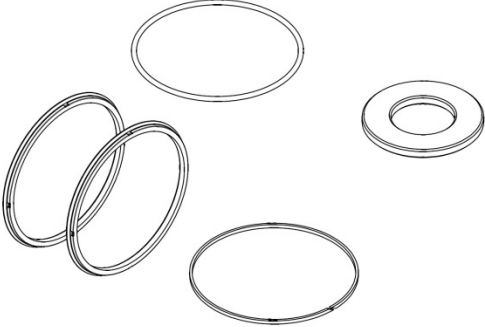
Pos.	Article	Quantity	Order Number: 1204-WG10-DS10
	Damping Ring	1	
	Guide Band	1	
	O-ring	1	
	Piston Seal	2	

Body

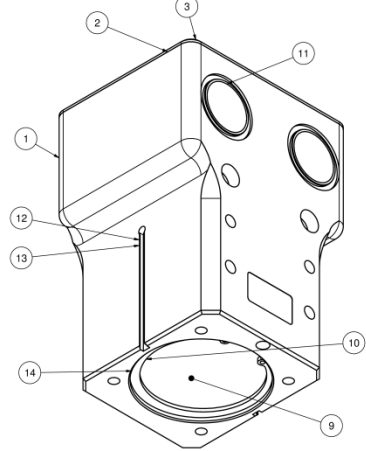
Pos.:	Article:	Quantity:	Order Number: 1205-WG10-GH10
1	Body	1	
2	Top Cover	2	
3	Fixing Screw	8	
10	Circlip	1	
9	Cylinder Cover	1	
11	Neck Bearing	4	
12	Slide Bearing	1	
13	Rod Seal	1	
14	O-ring	1	

Counter Bearing

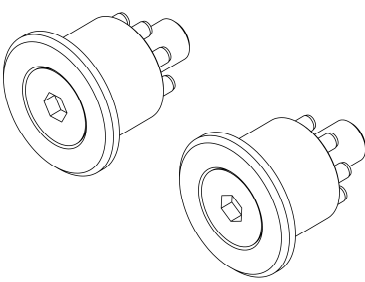
Pos.	Article	Quantity	Order Number: 1206-WG10-WL10
7	Counter Bearing	2	
	Pin	16	

Address:

GMG – Gesellschaft fuer modulare Greifersysteme mbH
Coesterweg 45c • 59494 Soest
Germany

Phone:

+49 (0)2921 - 4062

Fax:

+49 (0)2921 - 4042

E-mail:

info@gmg-system.com

Homepage:

http://www.gmg-system.com

Spare Part List for Gripper **W110**

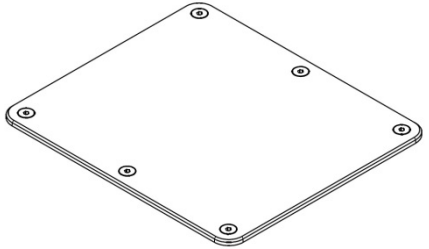
Top Cover			
Pos.	Article	Quantity	Order Number: 1207-WG10-AB10
2	Top Cover	2	
3	Fixing Screw	6	

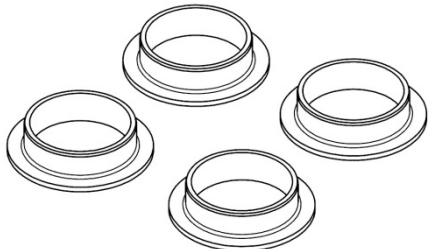
Neck Bearing			
Pos.	Article	Quantity	Order Number: 1210-WG10-HL10
	Neck Bearing	4	

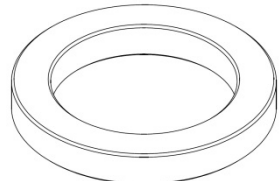
Ring Magnet			
Pos.	Article	Quantity	Order Number: 1213-WG10-MR10
	Ring Magnet	1	

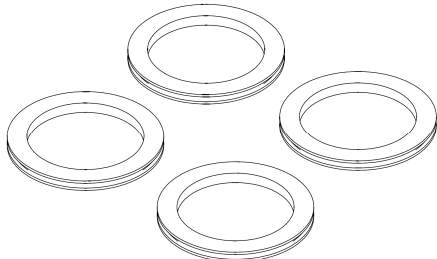
Finger Seal			
Pos.	Article	Quantity	Order Number: 1214-WG10-FD10
	Finger Seal	4	

Address:

GMG – Gesellschaft fuer modulare Greifersysteme mbH
Coesterweg 45c • 59494 Soest
Germany

Phone:

+49 (0)2921 - 4062

Fax:

+49 (0)2921 - 4042

E-mail:

info@gmg-system.com

Homepage:

http://www.gmg-system.com

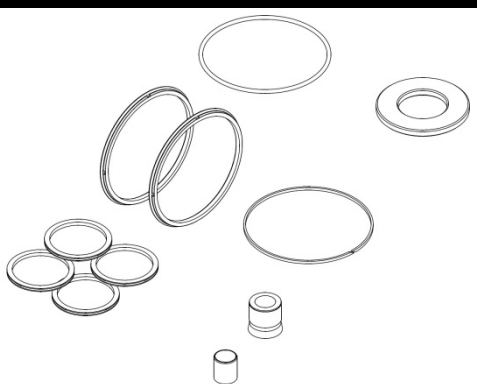

Spare Part List for Gripper **W110**

Seal Kit (complete)			
<i>Pos.:</i>	<i>Article:</i>	<i>Quantity:</i>	Order Number: 1290-WG10-DS10
	Damping Ring	1	
	Slide Bearing	1	
	Rod Seal	1	
	Guide Band	1	
	O-ring	1	
	Piston Seal	2	
	Finger Seal	4	

Proximity Switch	
<i>Scope of Delivery:</i>	Order Number:
<i>Proximity Switch (PNP) without Extension Cord</i>	1049-WG10-PN00
<i>Proximity Switch (PNP) with Extension Cord</i>	1049-WG10-PN01

**We only deliver to the INCOTERMS latest edition.
All printing and clerical errors are subject to correction without liability!
Prices and delivery times upon request.**

Revision Date: 12.01.2017

Address:

GMG – Gesellschaft fuer modulare Greifersysteme mbH
Coesterweg 45c • 59494 Soest
Germany

Phone:

+49 (0)2921 - 4062

Fax:

+49 (0)2921 - 4042

E-mail:

info@gmg-system.com

Homepage:

http://www.gmg-system.com