

Assembly Drawing (Typ: W210)

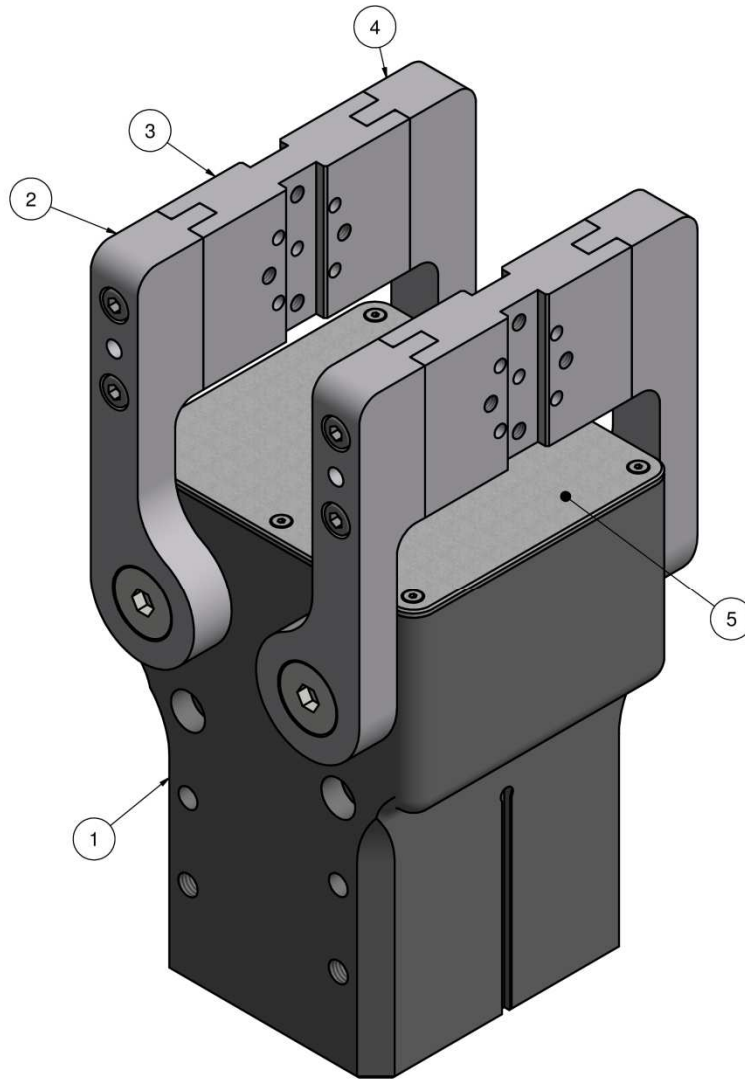
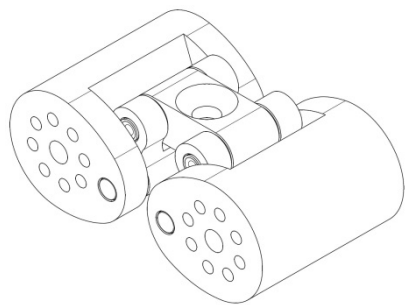
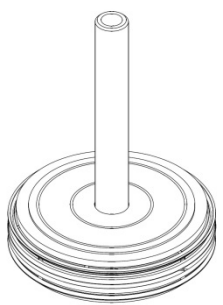

Spare Part List for Gripper **W210**

Gear Unit			
Pos.	Article	Quantity	Order Number: 1201-WG10-GE10
	Gear Unit	1	

Piston Unit			
Pos.	Article	Quantity	Order Number: 1202-WG10-KE10
	Kolbeneinheit	1	

Finger (single)			
Pos.	Article	Quantity	Order Number: 1203-W210-FE10
2	Finger left	1	
4	Finger right	1	
3	Pad Holder	1	
	Fixing Screw	2	
	Fixing Screw	4	
	Pin	2	
	Pin	16	

Hausanschrift:

GMG – Gesellschaft fuer modulare Greifersysteme mbH
Coesterweg 45c • D-59494 Soest

Telefon:

+49 (0)2921 - 4062

Telefax:

+49 (0)2921 - 4042

E-Mail:

info@gmg-system.com

Homepage:

http://www.gmg-system.com

Spare Part List for Gripper **W210**

Finger Set

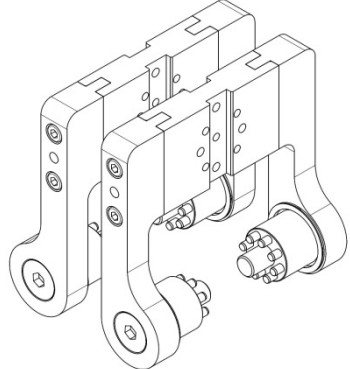
Pos.	Article	Quantity	Order Number: 1203-W210-FS10
2	Finger left	2	
4	Finger right	2	
3	Pad Holder	2	
	Fixing Screw	4	
	Fixing Screw	8	
	Pin	4	
	Pin	32	
	Finger Seal	4	

Seal Kit (small)

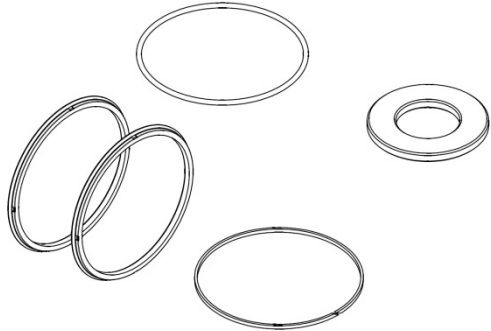
Pos.	Article	Quantity	Order Number: 1204-WG10-DS10
	Damping Ring	1	
	Guide Band	1	
	O-ring	1	
	Piston Seal	2	

Body

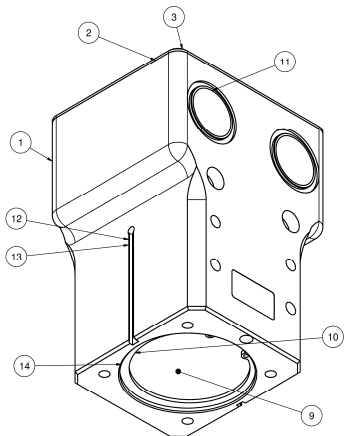
Pos.:	Article:	Quantity:	Order Number: 1205-WG10-GH10
1	Body	1	
2	Top Cover	2	
3	Fixing Screw	8	
10	Circlip	1	
9	Cylinder Cover	1	
11	Neck Bearing	4	
12	Slide Bearing	1	
13	Rod Seal	1	
14	O-ring	1	

Spare Part List for Gripper **W210**

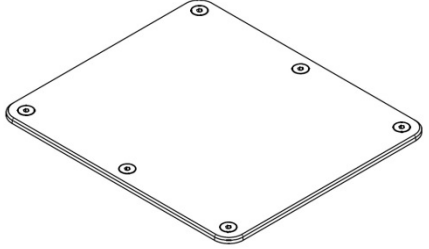
Stirnblech			
<i>Pos.</i>	<i>Article</i>	<i>Quantity</i>	Order Number: 1207-WG10-AB10
2	Top Cover	2	
3	Fixing Screw	6	

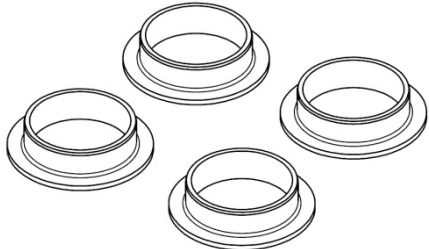
Neck Bearing			
<i>Pos.</i>	<i>Article</i>	<i>Quantity</i>	Order Number: 1210-WG10-HL10
	Neck Bearing	4	

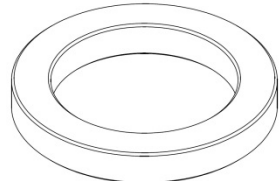
Ring Magnet			
<i>Pos.</i>	<i>Article</i>	<i>Quantity</i>	Order Number: 1213-WG10-MR10
	Ring Magnet	1	

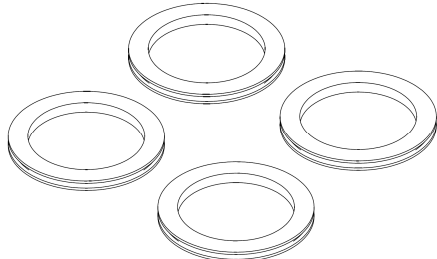
Finger Seal			
<i>Pos.</i>	<i>Article</i>	<i>Quantity</i>	Order Number: 1214-WG10-FD10
	Finger Seal	4	



Spare Part List for Gripper **W210**

Seal Kit (complete)

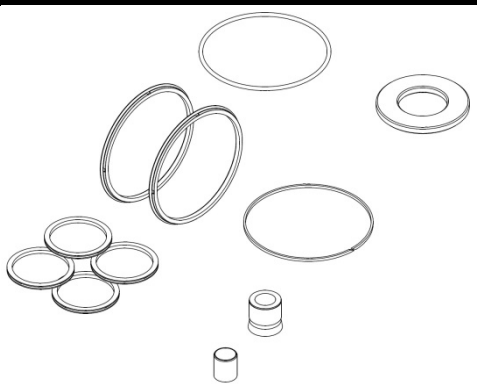
Pos.:	Article:	Quantity:	Order Number: 1290-WG10-DS10
	Damping Ring	1	
	Slide Bearing	1	
	Rod Seal	1	
	Guide Band	1	
	O-ring	1	
	Piston Seal	2	
	Finger Seal	4	

Proximity Switch

Lieferumfang:	Order Number:
Signalgeber (PNP) mit Stecker ohne Verlängerungskabel	1049-WG10-PN00
Signalgeber (PNP) mit Stecker und Verlängerungskabel	1049-WG10-PN01

We only deliver to the INCOTERMS latest edition.
 All printing and clerical errors are subject to correction without liability!
 Prices and delivery times upon request.

Stand: 12.01.2017

Hausanschrift:

GMG – Gesellschaft fuer modulare
 Greifersysteme mbH
 Coesterweg 45c • D-59494 Soest

Telefon:

+49 (0)2921 - 4062

Telefax:

+49 (0)2921 - 4042

E-Mail:

info@gmg-system.com

Homepage:

http://www.gmg-system.com