

Zusammenbauzeichnung (Typ: W203)

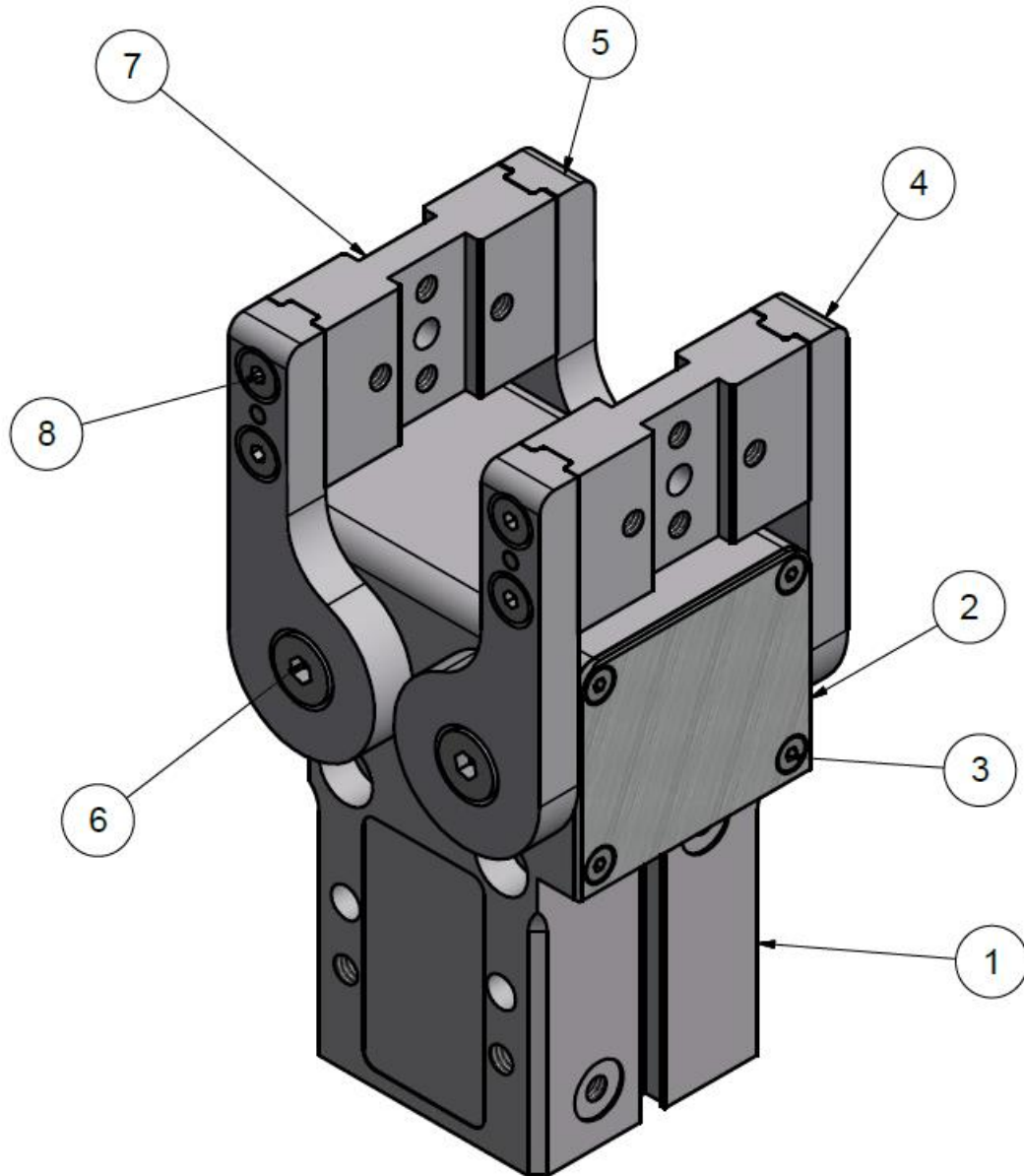
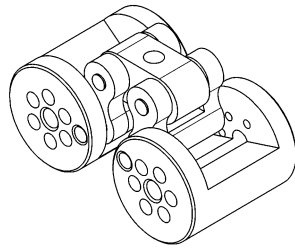

## Getriebeeinheit

Positions-Nr.	Artikel	Menge	Bestellnummer: 1201-WG03-GE03
	Getriebeeinheit komplett	1	

## Kolbeneinheit

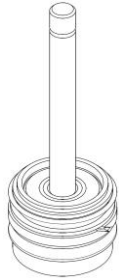
Positions-Nr.	Artikel	Menge	Bestellnummer: 1202-WG03-KE03
	Kolbenstange	1	

## Finger (einzeln)

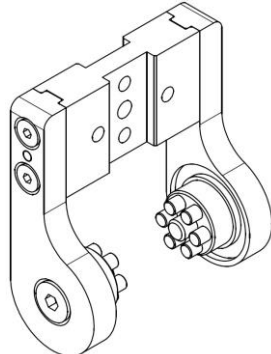
Positions-Nr.	Artikel	Menge	Bestellnummer: 1203-W203-FL03
4	Finger links	1	
5	Finger rechts	1	
8	Befestigungsschraube	4	
6	Befestigungsschraube	2	
	Zylinderstift	2	
	Zylinderstift	12	
7	Backenträger	1	

## Fingerset

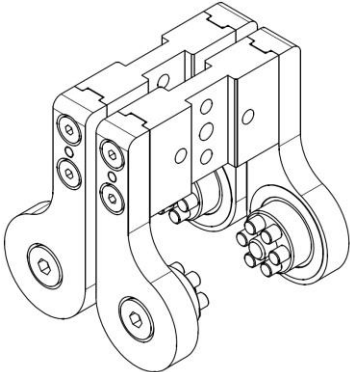
Positions-Nr.	Artikel	Menge	Bestellnummer: 1203-W203-FS03
4	Finger links	2	
5	Finger rechts	2	
8	Befestigungsschraube	8	
6	Befestigungsschraube	4	
	Zylinderstift	24	
	Zylinderstift	4	
	Fingerdichtung	4	
7	Backenträger	2	

## Dichtungssatz

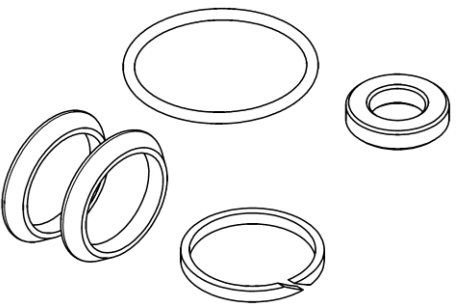
Positions-Nr.	Artikel	Menge	Bestellnummer: 1204-WG03-DS03
	Dämpfungsring	1	
	Führungsband	1	
	O-Ring	1	
	Kolbendichtung	2	

## Gehäuse

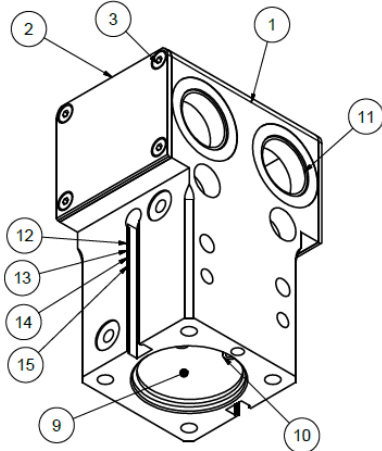
Positions-Nr.	Artikel	Menge	Bestellnummer: 1205-WG03-GH03
9	Zylinderdeckel	1	
1	Gehäuse	1	
2	Abdeckblech	2	
10	Sicherungsring	1	
3	Befestigungsschraube	8	
11	Halslager	4	
12	Gleitlager	1	
13	Stangendichtung	1	
14	O-Ring	1	
15	Haltering	1	

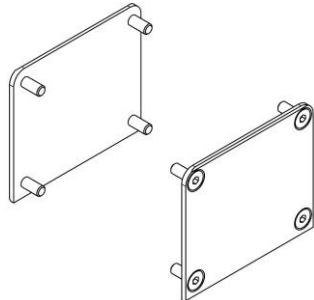
<b>Abdeckbleche</b>			
<i>Positions-Nr.</i>	<i>Artikel</i>	<i>Menge</i>	<b>Bestellnummer: 1207-WG03-AB03</b>
2	Abdeckblech	2	
3	Befestigungsschraube	8	

<b>Reduktionshülse</b>			
<i>Positions-Nr.</i>	<i>Artikel</i>	<i>Menge</i>	<b>Bestellnummer: 1208-WG03-RH03</b>
	Reduktionshülse	1	
	O-Ring	2	

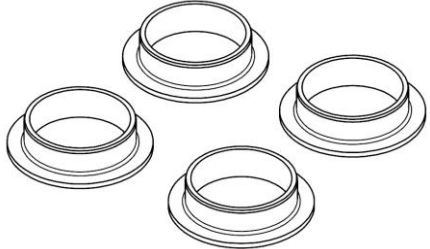
<b>Halslager (Gleitlager)</b>			
<i>Positions-Nr.</i>	<i>Artikel</i>	<i>Menge</i>	<b>Bestellnummer: 1210-WG03-HL03</b>
11	Halslager	4	

<b>Blindstopfen</b>			
<i>Positions-Nr.</i>	<i>Artikel</i>	<i>Menge</i>	<b>Bestellnummer: 1211-WG03-BS00</b>
	Blindstopfen, kurz	2	

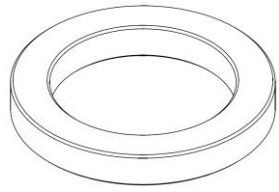
<b>Magnetring</b>			
<i>Positions-Nr.</i>	<i>Artikel</i>	<i>Menge</i>	<b>Bestellnummer: 1213-WG03-MR03</b>
	Magnetring	1	

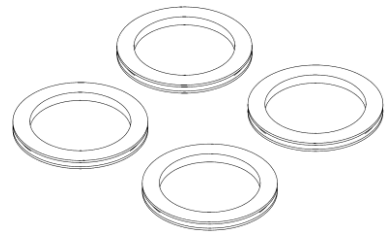
<b>Fingerdichtung</b>			
<i>Positions-Nr.</i>	<i>Artikel</i>	<i>Menge</i>	<b>Bestellnummer: 1214-WG03-FD03</b>
	Fingerdichtung	4	

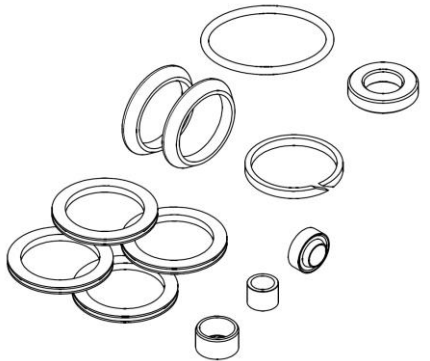
<b>Dichtungssatz 03</b>			
<i>Positions-Nr.</i>	<i>Artikel</i>	<i>Menge</i>	<b>Bestellnummer: 1290-WG03-DS03</b>
	Dämpfungsring	1	
	Gleitlager	1	
	Stangendichtung	1	
	Führungsband	1	
	O-Ring	1	
	Kolbendichtung	2	
	Fingerdichtung	4	
	Haltering	1	

<b>Signalgeber</b>	
<i>Lieferumfang</i>	<b>Bestellnummer</b>
<i>Signalgeber (PNP) ohne Verlängerung</i>	<b>1049-WG03-PN00</b>
<i>Signalgeber (PNP) mit Verlängerung</i>	<b>1049-WG03-PN01</b>

Es gelten ausschließlich unsere Verkaufs-, Liefer- und Zahlungsbedingungen.  
 Alle Preise verstehen sich zuzüglich Verpackungs- und Versandkosten, sowie der gesetzlichen Mehrwertsteuer.  
 Fehler bzw. Irrtümer nicht ausgeschlossen!

Stand: 25.03.2015